

CRAFTED LIKE NO OTHER

DON'T JUST SETTLE
FOR THE SAME
OLD BULL

OWNER MANUAL

ISUZU
D-MAX 2017+

AFN[®]
4 X 4 ACCESSORIES

WELCOME TO THE AFN FAMILY

This manual contains the **Isuzu D-MAX +2017** fitting instructions for:

Side Steps Ref.: 48002420

Nerf Bars Ref.: 48002426

1 INTRODUCTION



The Company

Founded in 1995, AFN - 4x4 Accessories dedicates itself to the production and commerce of all-terrain accessories. Its constant concern in its customers total satisfaction, and in the ideals of innovation and transformation have granted a position of notability both in the national and international panorama.

The only company in Portugal in the mass production of 4x4 accessories, relies on specialized and experienced technicians, with the most adequate knowledge, to an efficient response capability to its customers demands.

Thanks to the specialization in the several areas of design and manufacture and to a constant investment in technology, AFN has been broadening its wide range of products, without ever neglecting the quality factor.

4x4 Accessories

In its diversity of products we can include, with all-terrain quality, protection, safety and aesthetic accessories.

And it is here that AFN invest on the best technology, the best cut precision of the raw material, and the transformation of products with the quality recognized in the marketplace.

AFN has, at its disposal, resources to test and analyse the resistance of its products and stands in the front row regarding the European homologation of materials dedicated to all terrain.

The contact with the most important test laboratories for vehicles, both in England, Spain and Germany, provides AFN with the know-how to manufacture a wide range of quality products.

Our Design Approach

AFN designs each accessory taking into consideration the original model lines and fixing points. We refuse to have a "one design fits all" solution and we are always looking forward to embrace new challenges on how to adjust a new product into a new model!

The days of just throwing on a bit of steel together to form a protection system are gone. AFN is leading the way modern vehicle protection components are manufactured. Other will follow, and it won't be long where the AFN approach to Styling, Fit, Form and Function will become the benchmark for all other manufacturers.





INDEX

AFN 4x4 Accessories

Product: **Side Steps**
Part Ref.: **48002420**

Product: **Nerf Bars**
Part Ref.: **48002426**

Introduction 2

1 Checklist 4

Product 48002420
Product 48002426

2 Fitting Instructions 6

3 D-MAX Catalogue 12

4 Warranty Terms 13

5 AFN 4x4 Partners 14



1 CHECKLIST



- In this section you have a checklist with all parts included for the installation of your AFN product
- This product should be installed as demonstrated in the product fitting instructions
- If verified that any component is damaged, please contact your nearest AFN distributor
- The specified parts will only fit in the models specified by AFN
- Do not modify any component of the product

This checklist is for product **48002420** and **48002426**. Please note that both are divided.

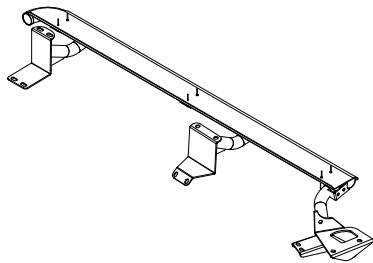

Ref.: 47001936

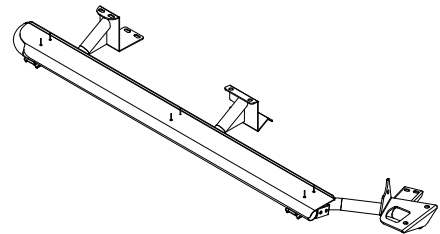

Ref.: 47001935



Ref.: 47001938

X1



Ref.: 47001937

X1



Ref.: 47001883

X2



Ref.: 47001882

X1



Ref.: 47001881

X1



Ref.: 47000164

X2



Ref.: 46007377

X2



Ref.: 46000139

X2



Zinc Plated
Ref.: 45000220
M10x40

X4



Zinc Plated
Ref.: 45000067
M12x35

X4



Zinc Plated
Ref.: 45000039
M10

X4



Zinc Plated
Ref.: 45000017
M10

X8



Zinc Plated
Ref.: 45000015
M10x25

X14



Zinc Plated
Ref.: 45000010
M10

X26



Zinc Plated
Ref.: 45000007
M10x30

X4

48002426

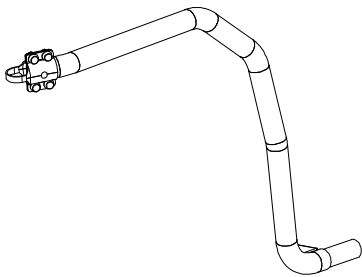

Ref.: 47001963

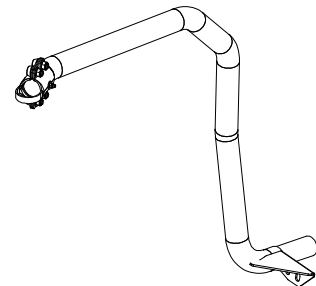

Ref.: 47001962



Ref.: 46006741

X2

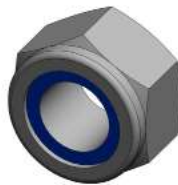

Ref.: 45000935
M10

X8



Ref.: 45000311
M10

X16



Ref.: 45000310
M10x25

X8



Ref.: 45000032
M10

X8

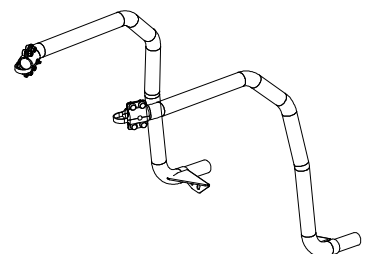
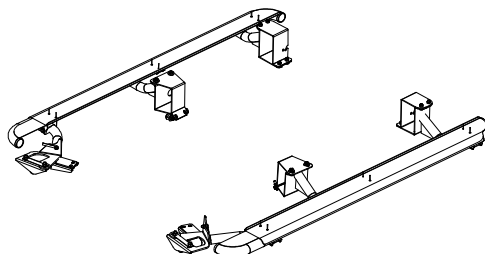

2 FITTING INSTRUCTIONS

WARNING:

Before you begin installation, read all instructions thoroughly.
Proper tools will improve the quality of installation and reduce the time required.

- This product should be installed as demonstrated in the *Product «Fitting Instructions»*;
- The specified parts, will only fit the models specified by **AFN**;
- Do not modify any component of the product;
- It is recommended that this product is installed by specialized and trained personnel;
- AFN doesn't take responsibility for changes made in the vehicle by its manufacturer;
- Work safely and use specialized tools at all times;
- **Always use protective gear.**



Size	Torque Nm	Torque lbft
M6	9 Nm	7 lbft
M8	22 Nm	16 lbft
M10	44 Nm	32 lbft
M12	77 Nm	57 lbft

Mouting Time

- 2,5 hours (Nerf Bars + Side Steps)
- 2 persons (recommended)

Tools Required

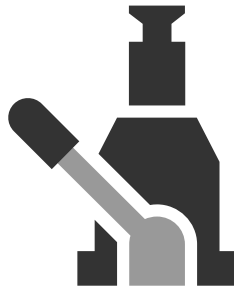
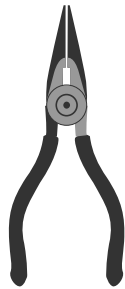
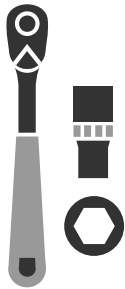

- Wrench
- Ratchet wrench
- Needle plier
- Hydraulic Jack
- Lift
- Drill

Step 1

AFN Side Steps

The AFN Side Steps should be as showed in the image.

Please mind that both **Fitting Instructions are equal**, so this **fitting instructions applies to both of them**.

The images shown are for the **Left Side Step**.



Step 2

ATTENTION!

Please mind that if you have both **AFN Side Steps** and **AFN Gearbox Skid Plate** remove the OEM* part shown in the image.

If not, ignore this step and proceed to the next step.

Be aware that you must save the OEM* bolts and nuts.



Step 3

Start by fitting **AFN Side Step - 47001936**, in the chassis.

Take on the supplied rounded shim with part number **46001639** and fit it between the chassis and the **AFN Side Step - 47001936**, as showed in the images.

Parts needed:

- 1 - 46000139;
- 2 - 47001883;
- 3 - 45000067; 45000042; M12x35

Just finger tight all bolts and nuts - **Do Not tighten yet.**



Tip: use a screwdriver to correctly and easily align the holes.



Tip: use a screwdriver to correctly and easily align the holes.

Step 4

Fit the **AFN Side Step - 47001936**, front part above the *OEM** part shown.

Bolts needed:
1 - *OEM** Bolts;

Just finger tight all bolts and nuts
- **Do Not tighten yet.**

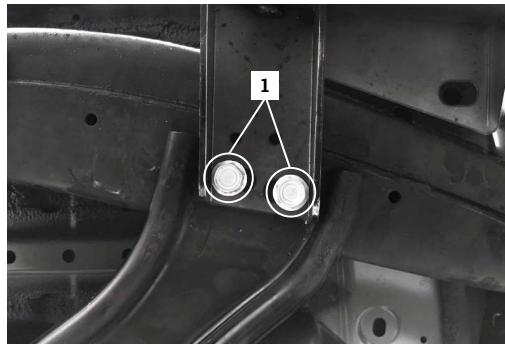

In our case, we do have the **AFN Gearbox Skid Plate** - ref.: **48002209**, so we have to remove the *OEM** part shown (**Step2**).

Step 5

In order to mount the rear part of the **AFN Side Step on the left side**, the Fuel Tank must be lowered.

You may use a jack to hold the Fuel Tank in the air while fitting the rear part of the **AFN Side Step**.



Be careful so you don't lower the Fuel Tank too much, it has the fuel pipe attached.

Step 6

Once the Fuel Tank is lowered, fit part number **47001938**.

It must enter from below and adjust it on the chassis. Then fit it to the **AFN Side Step**. Remind to untight the *OEM** cable holder and fit it on top of part number **47001938**.

Parts needed:
1 - 47001983;
2 - 45000015; 45000010;
M10x25
3 - *OEM** cable holder and bolt;

Just finger tight all bolts and nuts - **Do Not tighten yet.**

Re-tight the *OEM** Fuel Tank bracket:
4 - *OEM** bolts;

Give the final torque on *OEM bolts.**

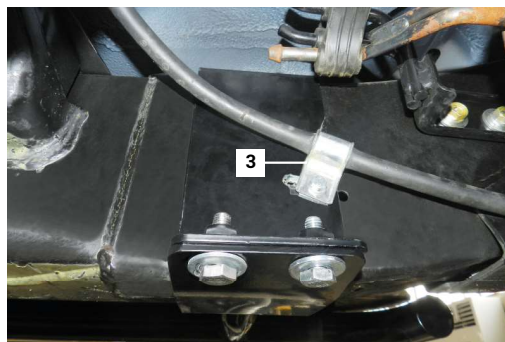
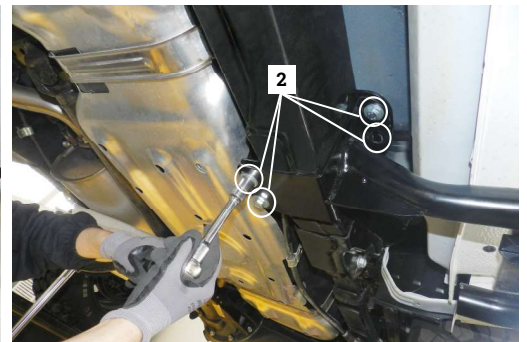

Step 7

The fitting process for the middle part is the same for part number **46007377**, as the previous, it must enter from below and adjust it on the chassi. Then fit it to the **AFN Side Step**. Parts needed:

1 - 45000007; 45000010 **x2**;
45000017; **M10x30**

2 - 45000220; 45000010 **x2**;
45000017; **M10x40**

Just finger tight all bolts and nuts - **Do Not tighten yet.**

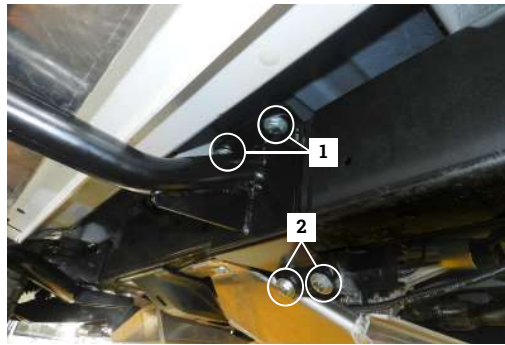

Step 8

Once everything is correctly fitted.

Give the final torque on all bolts.

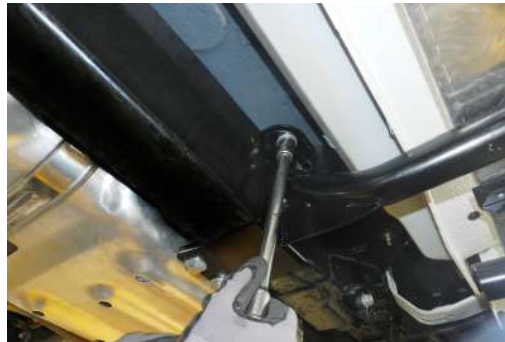

Step 9

Once everything is fully tightened, go to the front of the **AFN Side Step** and drill a hole on the chassi through an existing hole.

Check image to see the correct positioning. Use a **Ø11mm drill**.

Once the drilling is done, fit part number **47000164**. Bolts needed:
2 - 45000015; 45000010;
M10x25

Give the final torque.



Step 10

*If you have the **AFN NERF BARS**, please ignore this step and proceed directly to **Step 12**.*

Fit part number **47001882**. Bolts needed.

1 - 45000015; 45000039;
M10x25

Give the final torque.

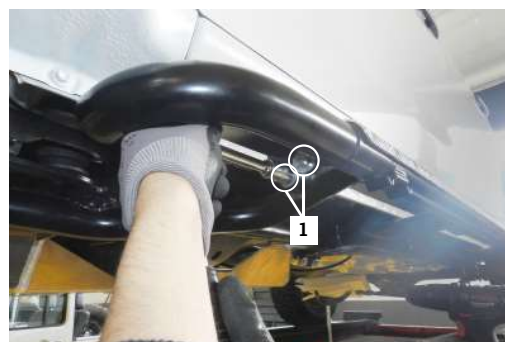

Step 11

Your new **AFN SIDE STEPS** are now installed on your **Isuzu D-MAX!**

Have Fun!



Reminder !

Before operating a vehicle fitted with an AFN Side Steps:
- Make sure all fittings are tightened

Maintenance | Care

Periodically check and tighten all nuts. Stripped, fractured or bent bolts or nuts need to be replaced.

NERF BARS - 48002426

Step 12

Fit the **AFN Nerf Bar** on the **AFN Side Bar** part number **47001963**.

Bolts needed.
1 - 45000015; 45000039;
M10x25

Give the final torque.
Please note that the AFN Nerf Bars will only be fitted in a AFN Side Steps.



Step 13

Fit the **bracket** part number **46006741**, joining the **AFN Nerf Bar** on the **AFN Bull Bar**.

Please note that the **AFN Nerf Bars** will only be fitted in the **AFN Bullbars (48002395)**.



Parts needed:

- 1 - 46006741;
- 2 - 45000015; M10x25
- 3 - 45000039; M10
- 4 - 45000017; M10
- 5 - 45000032; M10

Give the final torque.

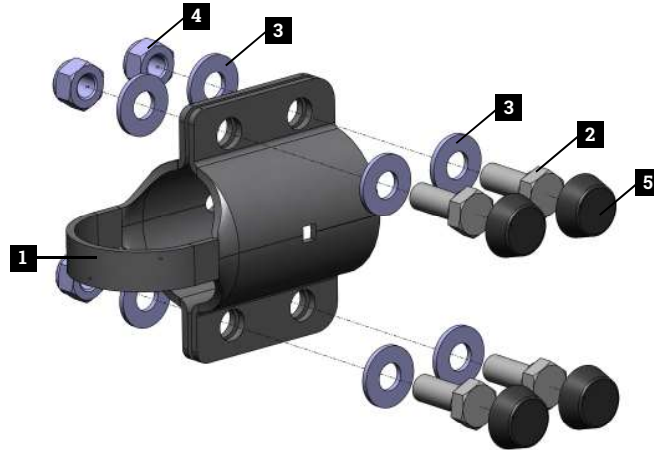

Step 14

Your new **AFN NERF BARS** are now installed on your **Isuzu D-MAX!**

Have Fun!



Reminder !

Before operating a vehicle fitted with an AFN Side Steps:
- Make sure all fittings are tightened

Maintenance | Care

Periodically check and tighten all nuts. Stripped, fractured or bent bolts or nuts need to be replaced.

3 D-MAX CATALOGUE



AFN 4x4 Accessories is becoming a well known brand for its products due to its quality, design and safety which are challenged for thousands of people everyday, worldwide.

In its diversity of products we can include, with all-terrain quality, protection, safety and aesthetic accessories. With that being said, **AFN 4x4** has some other accessories that every offroad passionate would like to have, such as **Body Protections, Underbody Protections, Light Holders, Storage** (Wheel Supports and Jerry-can carriers) and others related to the **Aesthetics**.

We have some 4x4 accessories that combine with the original model lines that if you take a closer look you will see that they don't appear to be an accessory, but a must-have.

Please be in mind that some accessories are available only to some models.

Feel free to check all the products that may interest you in our website at: www.afn.pt



Ref.: 48002396 - Front Bumper



Ref.: 48002395 - Bull Bar with fog lights



Ref.: 48002420 - Side Steps



Ref.: 48002339 - Rear Step Bar w/ trailer hitch



Ref.: 48002426 - Nerf Bars



Ref.: 48002188 - Rear Bumper w/ Wheel and Jerry-can carrier



Ref.: 48002205 - Front Skid Plate (*Al)



Ref.: 48002207 - Sump Guard Skid Plate (*Al)

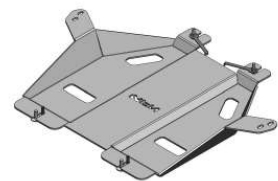

Ref.: 48002209 - Gearbox Skid Plate (*Al)

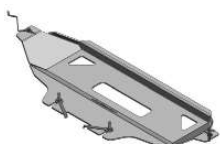

Ref.: 48002211 - Transfer Box Skid Plate (*Al)



4 WARRANTY TERMS

AFN4x4 products are warranted free from defects in materials and workmanship for a period of two (2) years from the date of initial retail purchase. Third-party components are delivered under the original manufacturer warranty.

Under the present warranty, **AFN4x4** obligation shall be limited to repairing, replacing or crediting, at its option, any part found to be defective.

AFN4x4 does not warrant or make any representations concerning its goods when:

- a) The products are purchased used, scratch and dent or when the box was opened.
- b) The products are not installed, used, and maintained strictly in accordance with **AFN4x4**'s instructions.
- c) The products are installed in vehicles that are used in competition.
- d) The products are installed in vehicles fitted with aftermarket non-standard tires with diameters in excess of OEM* specifications.
- e) The products are installed in vehicles with engines that have been modified to increase performance.

AFN4x4 will not be responsible for goods damaged in transit. If any goods arrive damaged, please contact the **AFN4x4** as soon as possible. **AFN4x4** will assess and may arrange to have the damaged goods returned to a **AFN4x4** Distributor and arrange for a replacement of the goods. Damaged goods must be returned in the condition received by you with all original packaging, accessories and/or manuals. If they are not returned in same condition sent there may be an additional fee charged.

To file a claim under this warranty please contact **AFN4x4** at +351 256 808 300 or via email at geral@afn.pt to request a *Returned Goods Authorization (RGA)* number and instructions for returning the defective component.

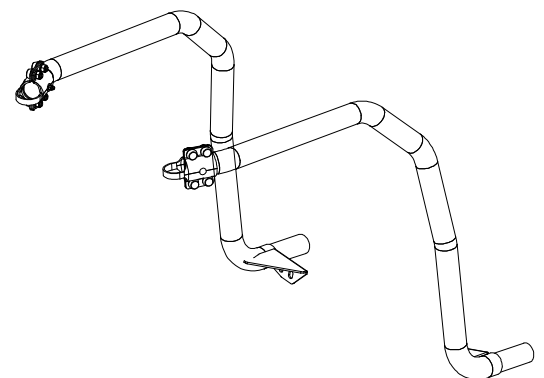
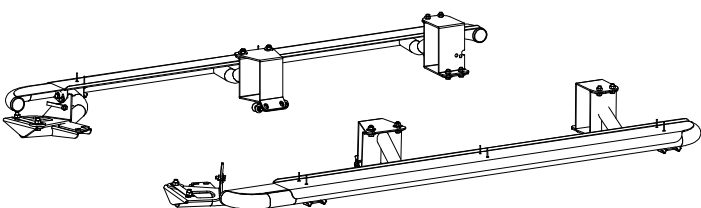

5 AFN 4x4 PARTNERS



01

Portugal

Rua da Madeira, 113
Z. Industrial das Travessas
3700-176 S. João da Madeira

T:(00351) 256 838 300/7
geral@afn.com
www.afn.com

02

Espanha

Carretera de Moledo 8
pol. ind. de Miraflores, Nave 20
36214, Vigo (Pontevedra)

T:(0034) 986 378338
info@4x4misutonida.com
www.4x4misutonida.com

03

Austrália

19 Flinders Parade
North lakes
QLD 4509

T:(0061) 1300 236 494
sales@afn4x4.com.au
www.afn4x4.com.au

04

Costa Rica

Fort overlanding CR,
Alajuela

T:(0011) 506 8430 0211
info@fortoverlanding.com
www.fortoverlanding.com

DON'T JUST SETTLE FOR THE SAME OLD BULL



WWW.AFN.PT | SALES@AFN.PT | FACEBOOK.COM/AFN4X4

WELCOME TO THE AFN FAMILY



União Europeia

Fundo Europeu de
Desenvolvimento Regional

